



CODE 54 - HEAT SHRINK BOOT BACKSHELL





201M116-19C-D

SERIES _____
 DASH NUMBER (TABLE 1) _____
 MATERIAL _____
 REFER TO CH00-0250-004
 FINISH _____
 REFER TO CH00-0250-004
 MODIFICATION CODE _____
 REFER TO CH00-0250-004 (2)

NOTES:

1. THIS PRODUCT IS DESIGNED TO TERMINATE A HEAT SHRINKABLE LIPPED BOOT TO A CONNECTOR.
- (2) FOR ADDITIONAL DIMENSIONS, ORDERING INFORMATION AND MODIFICATIONS, SEE CH00-0250-004.
3. ADAPTOR TO BE PERMANENTLY MARKED/BAGGED AND LABELLED WITH CODE IDENTIFICATION NUMBER AND PART NUMBER. (e.g. 06090-201M112-19A).
- (4) BACKSHELL MATES TO MIL-C-81703, SERIES III, MS3424, MS3446, MS3464, MS3467, MS3468, CLASS E & L
- (5) BACKSHELL MATES TO MIL-C-5015G, MS3400 SERIES, CLASS D, E, K, L, U & W, MS3400, MS3401, MS3404, MS3406, MS3450, MS3451, MS3454, MS3456, MS3470, MS3471, MS3472, MS3474, MS3475, MS3476. MIL-C-83723, SERIES II, CLASS A & L. MIL-C-83723, SERIES I & III, CLASS A, G, K, R & S: M83723/1, /2, /3, /4, /5, /6, /7, /8, /13, /14, /36, /37, /38, /40, /41, /42, /43, /48, /49, /65, /66, /67, /68, /69, /70, /71, /72, /73, /74, /75, /76, /77, /78, /82, /83, /84, /85, /86, /87, /91, /92, /95, /97, /98, (MS3155 CONTROLLED INTERFACE).
- (6) WHEN "L" MODIFICATION IS SPECIFIED, COUPLING NUT SHALL HAVE 3 WIRE HOLES, 120° APART.

If this document is printed it becomes uncontrolled. Check for the latest revision

DRAWN	K.WINCZURA	DATE 19/02/2015	 3RD ANGLE PROJECTION NOT TO SCALE	TITLE: HEAT SHRINK BOOT BACKSHELL	 Polamco  connectivity		
CHECKED		19/02/2015					
APPROVED	K.SHEPPARD	03/03/2015					
APPROVED	H.SMITH	20/08/2015					
UNLESS OTHERWISE SPECIFIED ALL DIMENSIONS IN MILLIMETRES GENERAL TOL LINEAR +/-0.25MM ANGULAR +/- 1°				ASSY USED ON: MIL-DTL-26482 SERIES II / MIL-DTL-83723 SERIES I & III	 connectivity		
REVISIONS							
LTR	DESCRIPTION	DATE	APPROVED				
J2	REVISED PER ECO-15-004707	26/03/2015	H.SMITH				
K	REVISED PER ECO-15-011999	20/08/2015	H.SMITH				
TE CAGE CODE: 06090 POLAMCO/TE CAGE CODE: U5792				TE CONNECTIVITY - POLAMCO LTD RESERVES THE RIGHT TO AMEND THIS DRAWING AND THE INFORMATION SET FORTH HEREON AT ANY TIME. USERS SHOULD INDEPENDENTLY EVALUATE THE SUITABILITY OF THE PRODUCT FOR THEIR APPLICATION.	DRAWING NO: 201M1XX	DRAWING REV: K	SHT 1

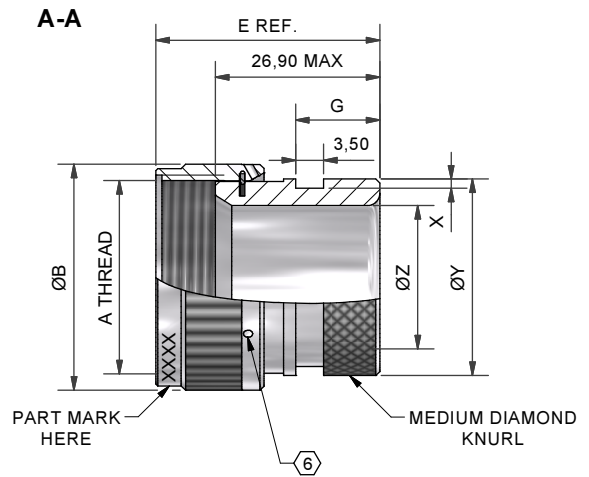





TABLE 1

BASE PART NUMBER	SHELL SIZE	A THREAD	ØB MAX	ØZ MIN	ØY +0,00/-0,50	X +0,20/-0,00	G	E REF.
201M103	03	9/16 -24UNEF	17,0	6,6	13,5	1,12	10,5	28,0
201M108	08	1/2 -20UNF	15,6	6,6	13,5	1,12	10,5	28,0
201M110	10	5/8 -24UNEF	18,6	9,3	15,4	1,12	10,5	28,0
201M112	12	3/4 -20UNEF	21,7	12,8	19,7	1,12	10,5	28,0
201M114	14	7/8 -20UNEF	24,9	14,7	21,3	1,12	10,5	28,0
201M116	16	1 -20UNEF	28,2	17,8	24,5	1,12	10,5	28,0
201M118	18	1 1/16 -18UNEF	30,9	19,8	26,5	1,12	10,5	28,0
201M120	20	1 3/16 -18UNEF	34,1	23,0	30,9	1,75	10,5	28,0
201M122	22	1 5/16 -18UNEF	37,3	26,2	34,4	1,75	10,5	28,0
201M124	24	1 7/16 -18UNEF	40,4	29,1	36,8	1,75	10,5	28,0
201M128	28	1 3/4 -18UNS	50,0	35,1	43,4	1,75	10,5	28,0
201M132	32	2 -18UNS	56,3	41,3	48,7	2,20	14,5	32,3
201M136	36	2 1/4 -16UN	62,7	46,8	55,1	2,20	14,5	32,3
201M140	40	2 1/2 -16UN	69,0	52,2	61,0	2,20	14,5	32,3
201M144	44	2 3/4 -16UN	75,4	58,7	67,5	2,20	14,5	32,3
201M148	48	3 -16UN	81,7	65,1	73,8	2,20	14,5	32,3
201M161	61	1 1/2 -18UNEF	42,0	30,1	38,8	1,75	10,5	28,0

If this document is printed it becomes uncontrolled. Check for the latest revision

DRAWN	K.WINCZURA	DATE 19/02/2015	 3RD ANGLE PROJECTION NOT TO SCALE	TITLE: HEAT SHRINK BOOT BACKSHELL	 Polamco 											
CHECKED		19/02/2015	UNLESS OTHERWISE SPECIFIED ALL DIMENSIONS IN MILLIMETRES GENERAL TOL LINEAR +/-0,25MM ANGULAR +/- 1°	ASSY USED ON: MIL-DTL-26482 SERIES II / MIL-DTL-83723 SERIES I & III												
APPROVED	K.SHEPPARD	03/03/2015		REVISIONS												
APPROVED	H.SMITH	20/08/2015	<table border="1" style="width: 100%; border-collapse: collapse;"> <thead> <tr> <th>LTR</th> <th>DESCRIPTION</th> <th>DATE</th> <th>APPROVED</th> </tr> </thead> <tbody> <tr> <td>J2</td> <td>REVISED PER ECO-15-004707</td> <td>26/03/2015</td> <td>H.SMITH</td> </tr> <tr> <td>K</td> <td>REVISED PER ECO-15-011999</td> <td>20/08/2015</td> <td>H.SMITH</td> </tr> </tbody> </table>	LTR	DESCRIPTION	DATE	APPROVED	J2	REVISED PER ECO-15-004707	26/03/2015	H.SMITH	K	REVISED PER ECO-15-011999	20/08/2015	H.SMITH	TE CAGE CODE: 06090 POLAMCO/TE CAGE CODE: U5792
LTR	DESCRIPTION	DATE	APPROVED													
J2	REVISED PER ECO-15-004707	26/03/2015	H.SMITH													
K	REVISED PER ECO-15-011999	20/08/2015	H.SMITH													
<small>TE CONNECTIVITY - POLAMCO LTD RESERVES THE RIGHT TO AMEND THIS DRAWING AND THE INFORMATION SET FORTH HEREON AT ANY TIME. USERS SHOULD INDEPENDENTLY EVALUATE THE SUITABILITY OF THE PRODUCT FOR THEIR APPLICATION.</small>				DRAWING NO: 201M1XX	DRAWING REV: K	SHT 2										